

Reference Manual – English

mu-so

Contents

<u>Section</u>	<u>Page</u>	<u>Section</u>	<u>Page</u>
Introduction	1	Diagram 16	
1. Getting Started	1	UPnP™ stream playing	14
1.1 Installation	2	Diagram 17	
1.2 Side Panel Features	2	Local inputs	14
Diagram 1		Diagram 18	
Place mu-so on a shelf or table	3	iRadio input	14
Diagram 2		5.2 The mu-so Remote Control Handset	15
mu-so underside connections	3	Diagram 19	
Diagram 3		mu-so remote handset	15
mu-so side panel features	3	5.3 The Naim app	16
2. Network Connection	4	Diagram 20	
2.1 Wireless Network Connection	4	Naim app setup	16
Diagram 4		Diagram 21	
Naim app setup screen	4	Naim app home	16
Diagram 5		Diagram 22	
Wireless Accessory Configuration	5	Naim app	
Diagram 6		settings	17
Wi-Fi key sharing	5	6. Installation Notes	18
Diagram 7		6.1 Handling mu-so	18
Setup web page - Overview	6	6.2 Cleaning mu-so	18
2.2 Wired Network Connection.	7	6.3 Grille Replacement	18
Diagram 8		6.4 Firmware Update	18
Setup web page - Network	7	6.5 Lightning Precautions	18
3. Bluetooth Connection	8	6.6 Defaults	18
Diagram 9		6.7 Problems?	18
Bluetooth setup	8	6.8 Service and Contact	18
4. Music Sources	9	7. Specifications	19
4.1 Local Sources	9	8. Acknowledgements	20
4.2 iRadio	9		
4.3 Streams	9		
5. Control	11		
5.1 The mu-so Touch Panel and Rotary Control	11		
Diagram 10			
Touch Panel and Rotary Control	12		
Diagram 11			
Touch Standby to switch on.	12		
Diagram 12			
Turn the rotary control to adjust volume.	12		
Diagram 13			
Bluetooth stream playing	13		
Diagram 14			
Spotify stream playing	13		
Diagram 15			
AirPlay stream playing	13		

Introduction

Welcome to mu-so® and congratulations on your purchase. Mu-so brings renowned Naim audio performance to a compact, all-in-one music player for the first time and combines its exceptional performance with a comprehensive collection of audio inputs and sources. With mu-so you can:

- Listen to thousands of internet radio stations.
- Stream audio using AirPlay®.
- Stream audio using Spotify® Connect (a Spotify Premium account is required).
- Play audio wirelessly using Bluetooth® with AAC and aptX® encoding from any compatible playback device.
- Play audio from UPnP™ music servers.
- Play audio stored on your iPod®, iPhone®, iPad® and other USB memory devices via a USB connection.
- Play analogue or digital audio using a wired connection from any playback device with a suitable audio output socket.

1. Getting Started

This manual provides comprehensive information on all mu-so features and facilities and will enable you to setup mu-so perfectly to integrate with your existing home entertainment systems and media.

If you wish to play some music immediately on unpacking mu-so, the Quick Start Guide found within its document pack will guide you quickly through the process of selecting and playing your desired audio source or stream. If you have questions not answered within these pages help can be found at: mu-sosupport@naimaudio.com, or by calling: +44 (0)333 321 9923 (UK)
+1 800 961 5681 (USA and Canada).

Mu-so can be controlled from either its touch panel and rotary control, its supplied remote control handset or the free mu-so iOS or Android app. The Naim app offers the most complete suite of control and setup facilities and we strongly recommend that before you begin to use mu-so you download and install the app on your iOS or Android phone or tablet. The Naim app can be found easily in both the iTunes App Store and Google Play Store.

Note: The Naim app requires iOS version 7.1 or later, or Android version 4.0 or later.

1. Getting Started

1.1 Installation

Mu-so is designed to be located either on a table, a furniture unit or a wall shelf. If a shelf is to be used be sure that it is able to support mu-so's 13kg (28.7lb) weight.

Important: Items of any weight placed on the mu-so top surface may damage its finish.

Important: Never place any item containing liquid, such as a vase, a cup or a glass, on the mu-so top surface.

Diagram 1 illustrates mu-so located on a shelf and a table.

A connection panel located on the mu-so underside incorporates a mains input socket, a wired network socket, and a TosLink optical digital audio socket intended for the connection of external digital audio sources; a CD player for example. The underside connection panel is illustrated in Diagram 2.

Important: Take great care when lifting and carrying mu-so, and when accessing the underside connection sockets. Do not stand mu-so on its front grille or either end panel, or invert it fully to stand on its top panel. Mu-so can be stood temporarily on its rear heatsink in order to gain access to the underside connection sockets. Ensure however that the heatsink is protected from damage.

If your mu-so is to use a wired network connection begin by connecting a standard Ethernet cable to the network socket. Otherwise, first connect mu-so to a suitable mains supply using the supplied mains cable.

Note: mu-so is supplied either with a single mains cable appropriate for the territory in which it is sold or with a single mains cable and a single-use localised adaptor.

Mu-so will immediately switch-on in standby mode when connected to a mains supply.

Mu-so has two standby modes: standby and deep sleep. In standby mode mu-so network and Bluetooth connections remain operational to enable it to "wake" automatically when in receipt of a Naim app control command or a music stream. In deep sleep mode, mu-so network and Bluetooth functions will shut-down in order to reduce power consumption to a minimum.

To switch mu-so into standby mode tap the touch panel Standby icon or press the handset Standby button. To switch mu-so into deep sleep mode touch and hold the touch panel Standby icon, or press and hold handset Standby button.

Note: If mu-so is unused for 20 minutes after waking from standby or deep sleep it will return to standby mode. This auto standby time can be adjusted via the Naim app Settings menus.

1.2 Side Panel Features

The mu-so right-hand side panel, illustrated in Diagram 3, also incorporates some connection and installation facilities. These include:

- A pin-hole Wi-Fi Key Sharing and factory defaults button. See Paragraph 2.1.2 for more on Wi-Fi Key Sharing and Section 6.6 for more on returning mu-so to its default settings.
 - A multicolour status indicator. See Section 2 for information on indicator colours.
 - A 3.5mm jack analogue audio socket for the connection of external analogue audio sources.
- Note:** mu-so will automatically select its side panel analogue input when a plug is inserted in the socket.
- A USB socket for the connection of USB memory hardware and audio playback hardware such as iOS and Android devices.

1. Getting Started

Diagram 1

Place mu-so on a shelf or table

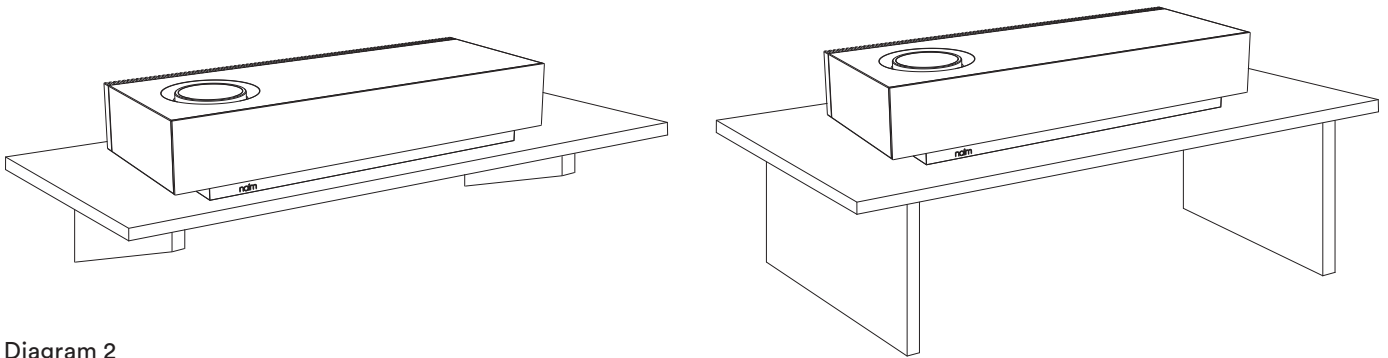
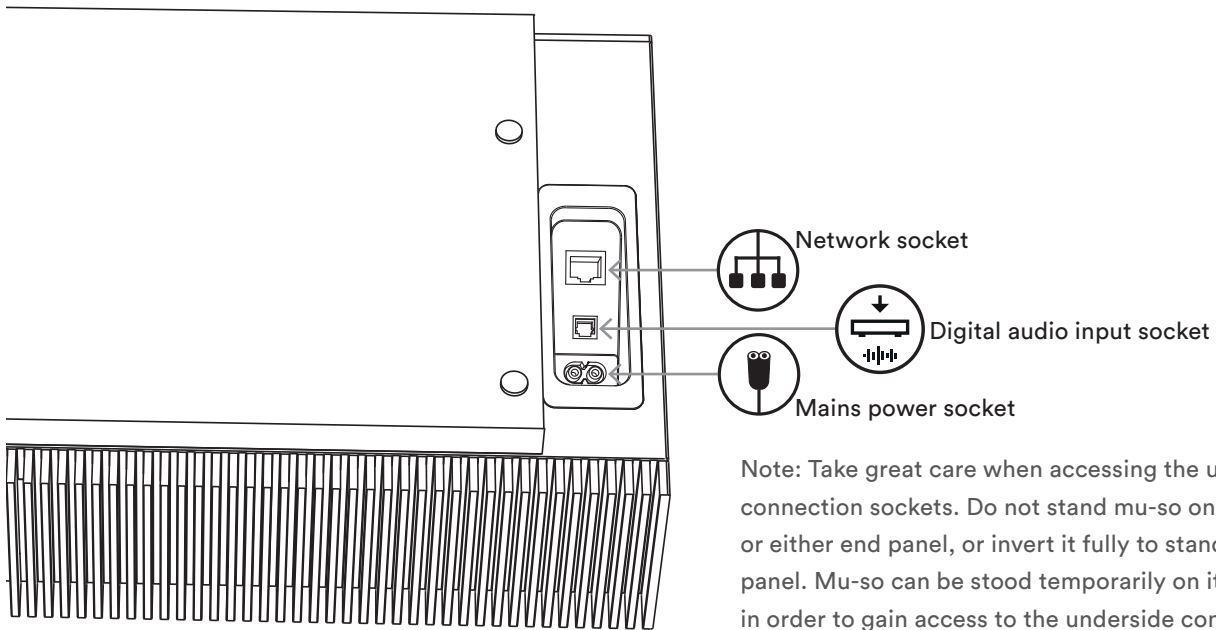

Diagram 2

mu-so underside connections



Note: Take great care when accessing the underside connection sockets. Do not stand mu-so on its front grille or either end panel, or invert it fully to stand on its top panel. Mu-so can be stood temporarily on its rear heatsink in order to gain access to the underside connection sockets. Ensure however that the heatsink is protected from damage.

Diagram 3

mu-so side panel features

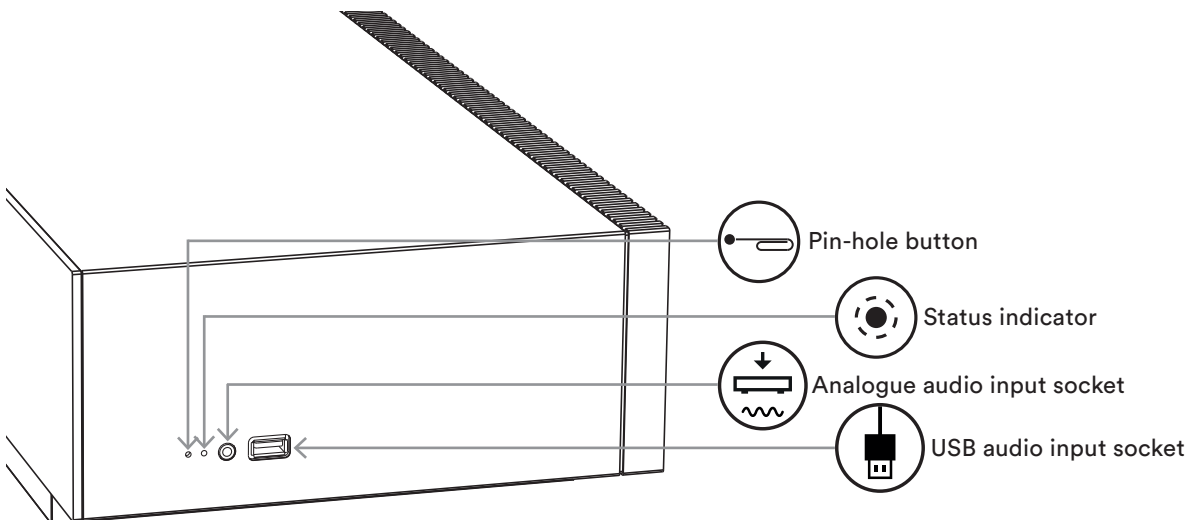

2. Network Connection

In order to play streamed audio files and internet radio stations mu-so must be connected to the internet via a local network. Mu-so can be connected to a local network via either a wired or wireless connection to a network router. The following paragraphs describe the procedures for wireless and wired connection.

Note: Mu-so is configured by default to communicate with TCP/IP networks automatically using the standard DHCP protocol. Mu-so can be configured to use a fixed IP address via its internal web setup pages. See Section 2.2 for more information.

Note: If your mu-so has been previously used it is good practice to return it to its default settings before attempting to connecting it to your network. The factory default procedure will erase any existing user and network settings and restore the default iRadio presets. See Section 6.6 for more information.

The indicator adjacent to the factory defaults button on the mu-so right-hand side panel illuminates to communicate different network and functional states. The illumination is listed in the following table:

<u>Illumination</u>	<u>Network and Functional State</u>
Off	Deep sleep/off
White	Network connected
Orange	Network connection starting
Purple	Wireless connection configured but network not found
Purple (flashing)	Wireless setup mode
Blue	Firmware update underway or unit in recovery mode
Red (flashing)	System fault or amplifier overload (contact your retailer or mu-so support)

2.1 Wireless Network Connection

In order for mu-so to connect to the internet via a local wireless network it must be configured with the wireless network name (SSID) and password (security key). There are three different methods achieving this. The method you choose will depend on personal preference and convenience.

Note: Mu-so is compatible with the 802.11b and 802.11g Wi-Fi standards.

2.1.1 Wireless Setup Using the Naim app

The Naim app incorporates a wireless setup routine that will guide you through the process of connecting mu-so wirelessly to your local network. If you have not already downloaded and installed the Naim app you should do so now. Follow the steps below to implement Naim app wireless setup routine.

- Ensure that the iOS or Android device on which you have installed the Naim app is connected to the same wireless network you wish your mu-so to use.
- Open the Naim app and select Setup new mu-so.
- Follow the on-screen instructions to connect mu-so to the wireless network. Diagram 4 illustrates the Naim app setup page.

Diagram 4
Naim app Welcome screen

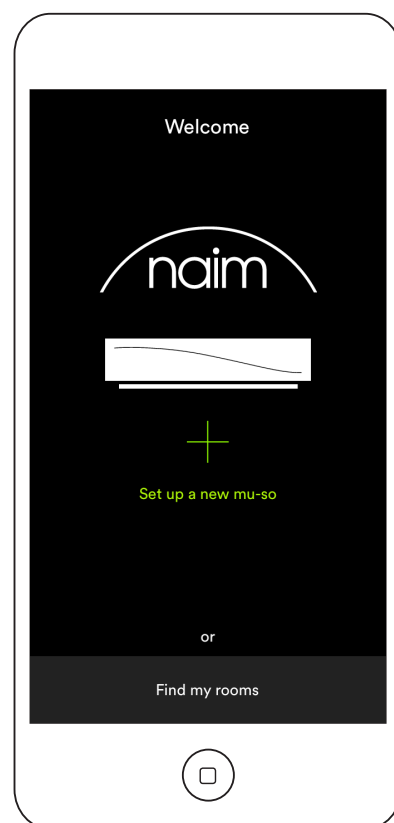

2. Network Connection

2.1.2: Wi-Fi Setup Using iOS Wireless Accessory Configuration

Mu-so can take advantage of the Wireless Accessory Configuration feature incorporated in iOS version 7. Wireless Accessory Configuration enables a wireless capable product such as mu-so to be configured automatically to join the same wireless network as the iOS mobile device. To use Wireless Accessory Configuration follow the steps below:

- Ensure that the wireless network that your iOS device is connected to is the one you wish your mu-so to use.
- Ensure mu-so is connected to a mains power supply and not in standby mode. Ensure no network cable is connected.
- Using the pin-tool supplied or a straightened paperclip briefly press the mu-so side panel pin-hole button to enter wireless set up mode. The status indicator adjacent to the button will flash purple.

Note: If your mu-so is previously unused it may start up in wireless set up mode with the indicator flashing purple.

- Open the wi-fi settings menu of the iOS device and scroll down the display. Select the SET UP NEW AIRPLAY SPEAKER item and follow the steps described. Diagram 5 illustrates the wi-fi settings menu.
- The Wireless Accessory Configuration procedure will now automatically send the network name and security key that the iOS device is using to your mu-so and set up its wi-fi configuration.
- The mu-so indicator will stop flashing and illuminate white when the wireless connection has been successfully established.

Diagram 5
Wireless Accessory Configuration

Note: Wireless Accessory Configuration is only available with iOS Version 7 or later.

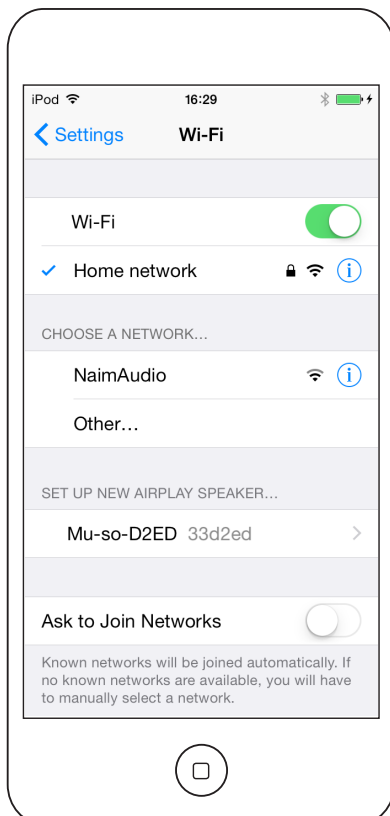

2.1.3: Wireless Setup Using iOS Wi-Fi Key Sharing

Mu-so can take advantage of the Wi-Fi Key Sharing feature incorporated in iOS version 6 or later. Wi-Fi Key Sharing enables a wireless capable product such as mu-so to connect via USB to an iOS device and automatically copy the network name and security key that the device is using. To use Wi-Fi Key Sharing follow the steps below:

- Ensure that the wireless network that your iOS device is connected to is the one you wish your mu-so to use.
- Ensure mu-so is connected to a mains power supply and not in standby mode. Ensure no network cable is connected.
- Connect the iOS device to the mu-so side panel USB socket. The iOS device must be switched on and unlocked.
- Using the pin-tool supplied or a straightened paperclip briefly press the mu-so side panel pin-hole button. The status indicator adjacent to the button will change colour and flash.
- A dialogue window will display on the iOS device screen requesting permission to share Wi-Fi settings. Select "Allow". Diagram 6 illustrates the dialogue window
- After approximately 30 seconds mu-so will be available for wireless streaming on your home network. The mu-so side-panel indicator will illuminate white.

Diagram 6
Wi-Fi key sharing

Note: Wi-Fi Key Sharing is only available with iOS Version 6 or later.

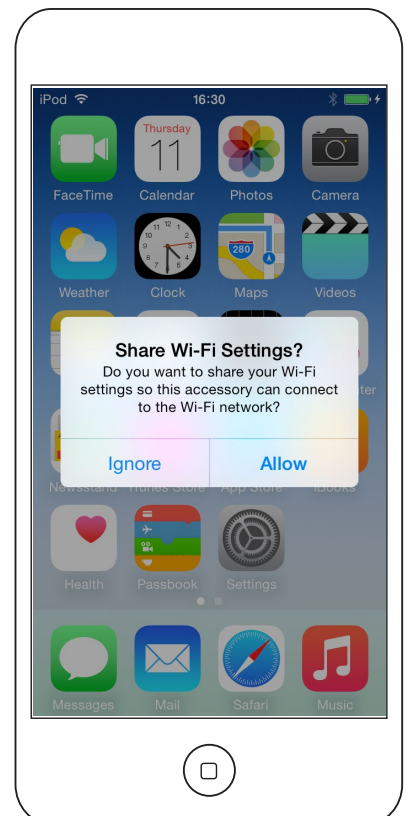

2. Network Connection

2.1.4: Wireless Setup Using a Wireless Connection

When not connected to a local wireless network, mu-so can broadcast its own wireless signal that can be used to access its internal web setup page. The name and password of the wireless network you wish mu-so to connect to can be specified on the setup page. To access the mu-so setup page wirelessly follow the steps below.

- Using the pin-tool supplied with mu-so, or a straightened paper clip, briefly press the pin-hole button located on the mu-so right-hand side panel. The indicator located next to the pin-hole button will change colour and flash.
- The mu-so wireless network broadcast will switch off after 30 minutes. It can be re-started by pressing the pin-hole button again.

Open the computer, laptop, tablet or smart phone wireless setup page or control panel and look for a local wireless network called (Mu-so-XXXX-Setup). This is a wireless network generated by mu-so itself that enables temporary connection for setup purposes.

Note: The default mu-so network and Bluetooth name incorporates the last four characters of the unique MAC address printed on a label on the underside of each unit adjacent to the mains input socket.

Select the mu-so wireless network and connect to it. No password will be required.

Note: Windows may require confirmation of network type. Select "Home".

- Close the computer, laptop, tablet or smart phone wireless setup page or control panel.
- Open a web browser window on the computer, laptop, tablet or smart phone and type 192.168.1.12 in the address bar. Press return or select "Go".
- The browser will display the mu-so Setup page. Select mu-so Wireless Setup and type your wireless network name and password in the appropriate dialogue boxes. Select Enter. Diagram 7 illustrates the mu-so Setup page home screen.
- Close the browser window.
- Return to the computer, laptop, tablet or smart phone wireless setup page or control panel and re-connect to your local network.
- Disconnect and then re-connect mu-so to the mains power supply and wake it from standby by touching its display Standby icon or pressing the handset Standby button.
- After a few moments your mu-so should be available for wireless streaming on your home network. The mu-so side-panel indicator will illuminate white.

Diagram 7
Setup web page - Overview

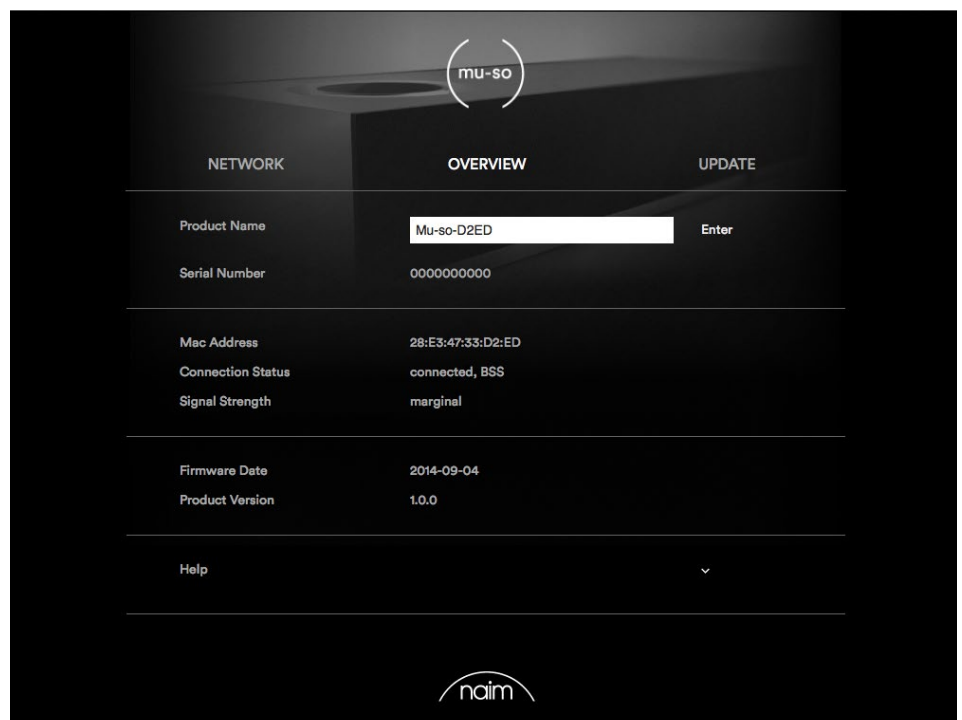

2. Network Connection

2.2 Wired Network Connection.

To connect mu-so to a local network using a wired connection follow the steps below:

- Disconnect mu-so from mains power.
- Connect mu-so to your local network router using a standard Ethernet cable.
- Re-connect mu-so to the mains power supply and wake it from standby by touching its display Standby icon or pressing the handset Standby button.

After a few moments mu-so should be available for streaming on your home network. The mu-so side-panel indicator will illuminate white.

Note: Mu-so can be configured to use a static IP address if required via the Advanced Settings tab on its setup page. Diagram 8 illustrates the setup page.

Diagram 8
Setup web page - Network

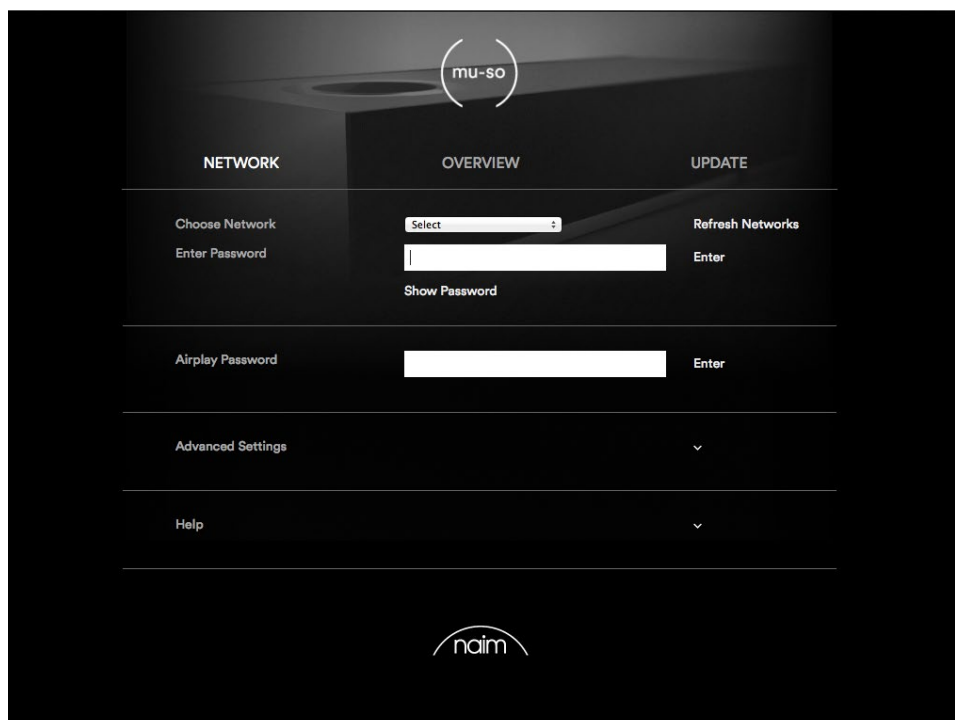

3. Bluetooth Connection

In addition to playing streamed audio via a local network, mu-so can play audio over a Bluetooth wireless connection from appropriately equipped playback devices. Mu-so is configured by default with an “open” Bluetooth connection so does not require “pairing” with a specific playback device. To connect mu-so to a Bluetooth playback device open the playback device Bluetooth setup page and select Mu-so-XXXX in the list of available devices. After a short delay mu-so will be available to the audio apps on the device for playback selection.

Note: Bluetooth wireless connections have a relatively limited range. A maximum of around 10 metres is typical in domestic environments, however physical obstructions in the transmission path may result in reduced range.

Note: The default mu-so network and Bluetooth name incorporates the last four characters of the unique MAC address printed on a label on the underside of each unit adjacent to the mains input socket.

Mu-so Bluetooth connection can be switched to a secure format using the setup pages of the IOS and Android Naim app (see Section 5.3.2). A secure Bluetooth connection means that connected devices need to be specifically “paired” with mu-so in order to stream audio. To switch mu-so to secure Bluetooth format follow the steps below:

- Open the Naim app setup menu and select Input Settings > Bluetooth Security. Select Bluetooth Security “on”.
- Touch and hold the mu-so touch panel input icon until the Bluetooth icon begins to blink.
- Open your Bluetooth playback device Bluetooth settings page and select “Mu-so-XXXX”.

Your mu-so and playback device will now be securely paired. No other Bluetooth device will be able to connect to mu-so unless it is similarly paired.

Note: If multiple devices are paired, mu-so will play from the first device from which it receives a stream. If you wish to stream from a different paired device, the first device must be disconnected.

Note: Up to eight Bluetooth devices can be paired with mu-so simultaneously. If a ninth device is paired the oldest paired device will be deleted.

Note: Mu-so can be forced to disconnect and delete a paired Bluetooth device via the Naim app settings menus. See section 5.3.2

Diagram 9 illustrates mu-so Bluetooth setup on an Android mobile device. Bluetooth setup on an iOS device is similar.

Diagram 9
Bluetooth setup

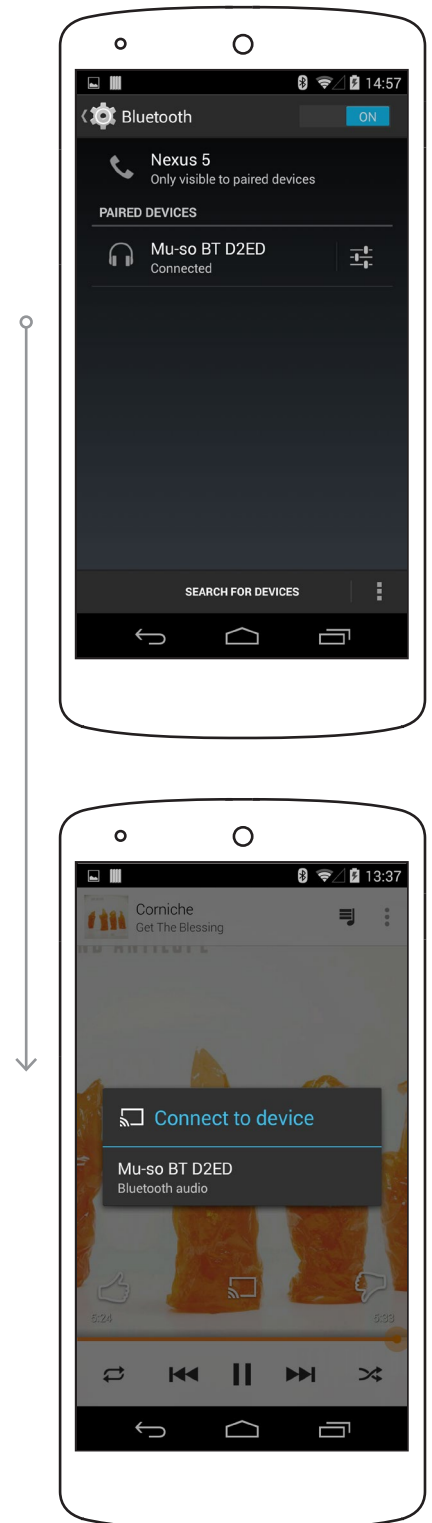

4. Music Sources

Mu-so can play audio from a wide variety of sources, however the way it behaves with each source will depend on the source. The following paragraphs describe different types of source and the manner in which mu-so will handle them.

4.1 Local Sources

Local sources are those for which source devices are connected directly to a mu-so input socket. They comprise the analogue and digital audio inputs and the USB audio input.

Local sources can be selected from the mu-so touch panel interface or using the Naim app. The analogue source input is automatically selected when a plug is inserted in the mu-so side panel input socket.

Note: The mu-so digital audio input is a TosLink socket compatible with S/PDIF digital audio signals. Many CD players incorporate an appropriate digital audio output.

The behaviour of USB devices connected to mu-so, and access to audio files they hold, varies depending on their type.

Audio files stored on USB memory devices can be browsed and selected for playback only by using the Naim app. Once playback is underway however the mu-so touch panel and handset can also be used to select play/pause, next or previous.

Audio files stored on iOS devices can be played through the mu-so USB input either under the local control of the iOS device or using the Naim app. In some cases, once playback is underway, the mu-so touch panel and handset can also be used to select play/pause, next or previous.

Note: Most UMS (Universal Mass Storage) USB devices are compatible with the mu-so USB input. Mobile devices using the Android operating system are not compatible with the mu-so USB input.

Mu-so can play audio files stored on USB memory hardware and playback devices in the following formats: MP3, ALAC, AAC, FLAC, WMA, WAV, AIFF or Ogg Vorbis.

4.2 iRadio

iRadio preset stations can be selected from the mu-so touch panel or using the Naim app (iRadio presets can also be selected from the touch panel by repeated touches of the radio icon). However, iRadio station browsing, searching and preset store functions are only available using the Naim app.

Note: Mu-so has five Naim favourite iRadio preset stations stored by default. These presets can be deleted and alternatives stored using the Naim app. Up to 40 preset iRadio stations can be stored using the Naim app with the first five always available for selection directly from the mu-so touch panel.

4.3 Streams

Mu-so streaming sources comprise AirPlay, Bluetooth, Spotify Connect, Multiroom and UPnP™.

Note: Mu-so is only able to play AirPlay, Spotify Connect, Multiroom and UPnP™ streams if it is connected to your local network. Section 2 of this manual covers mu-so network connection.

4.3.1 AirPlay, Bluetooth and Spotify Connect

AirPlay, Bluetooth and Spotify Connect cannot be selected from the mu-so touch panel or the Naim app, but are selected automatically when mu-so is in receipt of an appropriate stream. To play an AirPlay, Bluetooth or Spotify Connect stream, open the playback application on the streaming device (your Windows or OS X computer or your iOS or Android tablet or phone) and select mu-so as the playback device. AirPlay, Spotify Connect or Bluetooth icons will illuminate on the mu-so touch panel to indicate receipt of a stream.

Note: More information on Airplay, Spotify Connect and Bluetooth can be found at:
<https://www.apple.com/airplay>
<https://www.spotify.com/connect>
<http://www.bluetooth.com>

4. Music Sources

4.3.2 Multiroom

Multiroom enables mu-so to play local network audio streams from Naim multiroom streamer family products connected on the same local network. The mu-so multiroom input is selected automatically when in receipt of a stream from a Naim streamer product. Mu-so can be disconnected from a multiroom stream by pressing its touch panel or remote handset stop buttons, or by selecting an alternative input.

Note: Naim multiroom streamer products include the NDX, ND5 XS, NAC-N 172 XS, SuperUniti, NaimUniti, UnitiQute and UnitiLite. Mu-so is not able to work as a multiroom server so a multiroom system containing only mu-so units is not possible. Contact your Naim retailer for more information on Naim multiroom systems.

Note: The mu-so multiroom input can be disabled via the Naim app Settings menu. Disabling the multiroom input can be useful to prevent other users in a household inadvertently playing audio through it.

4.3.3 UPnP™

The mu-so UPnP™ input enables mu-so to play audio files stored on UPnP™ servers such as the Naim UnitiServe, network servers with integrated UPnP™ software, or on Windows and OS X computers. The mu-so UPnP™ input is selected automatically when in receipt of a stream from a server. UPnP™ file browsing can be carried out using the Naim app. Once playback has been initiated by a play command on the Naim app, the mu-so touch panel or remote handset play/pause, next and previous controls can also be used to control playback.

Mu-so can play UPnP™ streamed audio files in the following formats: MP3, ALAC, AAC, FLAC, WMA, WAV, AIFF or Ogg Vorbis. Files must be free of any digital rights management playback restrictions.

Note: Windows Media™ Player version 11 or above incorporates built in UPnP™ support. A variety of third party UPnP™ applications are available that are compatible with both Windows and OS X operating systems.

Note: More information on UPnP™ servers and networks can be found in the Naim knowledge base at: <http://www.naimaudio.com/knowledge-base>

5. Control

Mu-so can be controlled from either its touch panel and rotary control, its supplied remote control handset or the Naim app. The Naim app offers a complete suite of mu-so control and setup facilities and we recommend that before you begin to use mu-so you download and install the app on your iOS or Android phone or tablet. The Naim app can be found easily in both the iTunes App Store and Google Play Store.

The three control interfaces are described in the following paragraphs.

5.1 The mu-so Touch Panel and Rotary Control

The mu-so touch panel display and rotary control enable selection of inputs and control of volume. Illumination display around the rotary control also indicates mu-so startup, streaming and operational processes.

To begin, touch the display Standby icon to wake mu-so from standby. The touch panel, illustrated in Diagrams 10 to 18, incorporates the following control features:

- Audio transport touch icons across the centre of the panel enable selection of play, pause, previous and next.

Note: Mu-so audio transport controls will only operate on USB and streaming audio sources and then only once play has been initiated from the Naim app.

- Above the transport icons are icons that illuminate to indicate the identity of a currently playing stream.
- In the lower half of the touch panel, radio and input touch icons indicate and enable the selection of the iRadio and local input sockets (analogue, USB and digital).

Note: AirPlay, Bluetooth, and Spotify Connect streams cannot be selected from the touch panel but are selected automatically when mu-so is in receipt of a stream over a wired or wireless network. Touch panel icons indicate the selection of AirPlay, Spotify, Bluetooth and UPnP™ streams.

- Around the circumference of the touch panel are eleven indicator segments that illuminate to indicate volume level, radio preset selection and local input selection.

The mu-so iRadio input is selected by touching the radio icon. Mu-so will initially play the last radio station selected. If this is one of the five mu-so radio presets, one of the five upper circumference segments will illuminate. Subsequent touches of the radio icon will select the next iRadio preset.

Note: iRadio station browsing and preset management functions are only available using the Naim app.

When one of the mu-so local inputs is selected by touching the input icon, one of the three upper circumference segments will illuminate to indicate selection of either the analogue input, digital input or USB input. Subsequent touches of the input icon will select the next local input.

Note: Mu-so will automatically select its side panel analogue input when a connection plug is inserted in the socket.

Note: While the mu-so USB input can be selected from the touch panel, audio file browsing and selection functions are only available using the Naim app.

- The metallic outer section of the touch panel rotates to adjust volume. While volume adjustment is underway the circumference indicators illuminate progressively to indicate volume level.

5. Control

Diagram 10
Touch Panel and Rotary Control

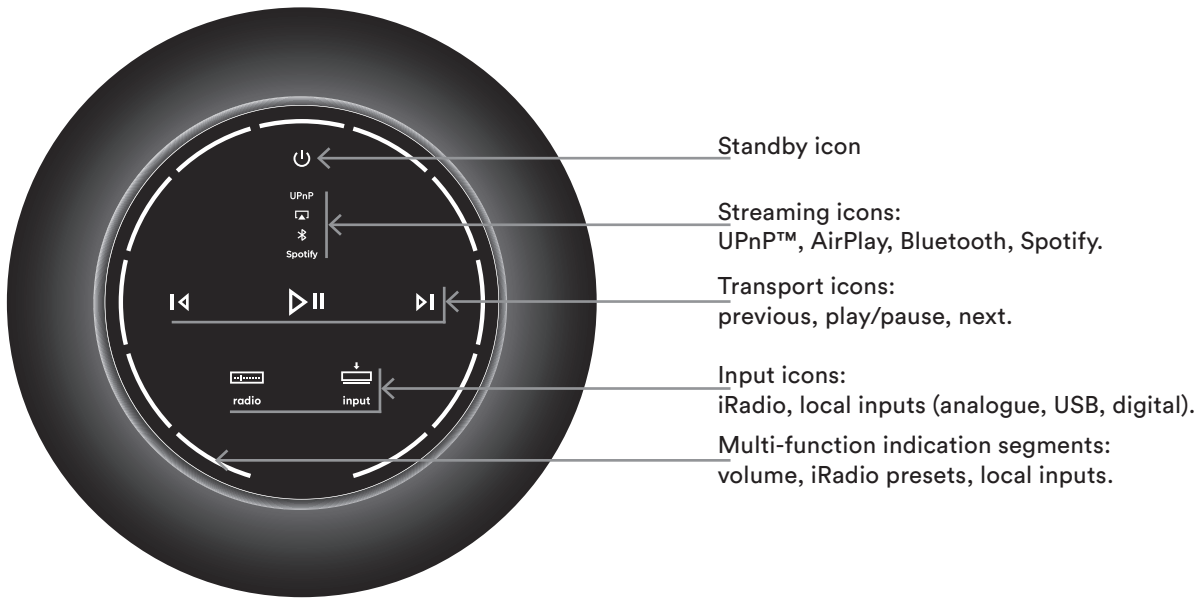

Note: Mu-so touch panel icons become selectively touch-active and illuminate depending on the input selected or playing. The touch panel in the illustration above shows all icons illuminated simultaneously for explanatory purposes.

Diagram 12
Turn the rotary control to adjust volume.

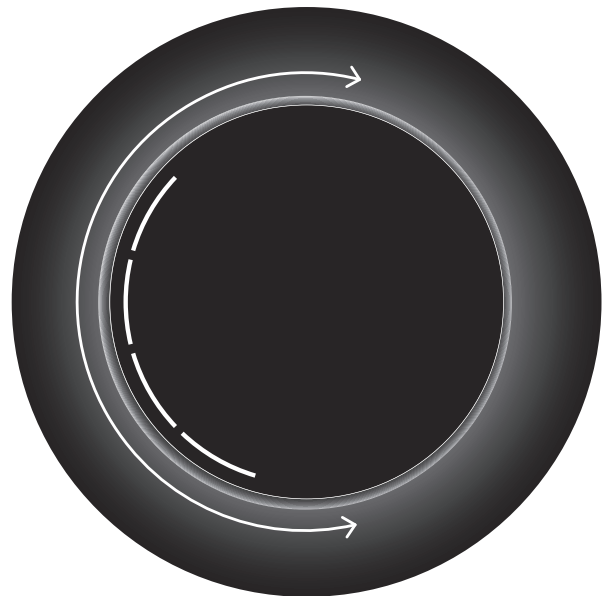

Diagram 11
Touch Standby to switch on.



5. Control

Diagram 13
Bluetooth stream playing



Bluetooth icon illuminated

Transport icons illuminated.

Note: Transport icons are only illuminated and touch-active once playback has been initiated from the Naim app or directly from a Bluetooth playback device.

Diagram 15
AirPlay stream playing



AirPlay icon illuminated

Transport icons illuminated and active.

Note: Transport icons are only illuminated and touch-active once playback has been initiated from the Naim app or directly from an AirPlay playback device.

Diagram 14
Spotify stream playing



Spotify icon illuminated

Transport icons illuminated and active.

Note: Transport icons are only illuminated and touch-active once playback has been initiated from the Naim app or directly from a Spotify Connect playback device.

5. Control

Diagram 16
UPnP™ stream playing

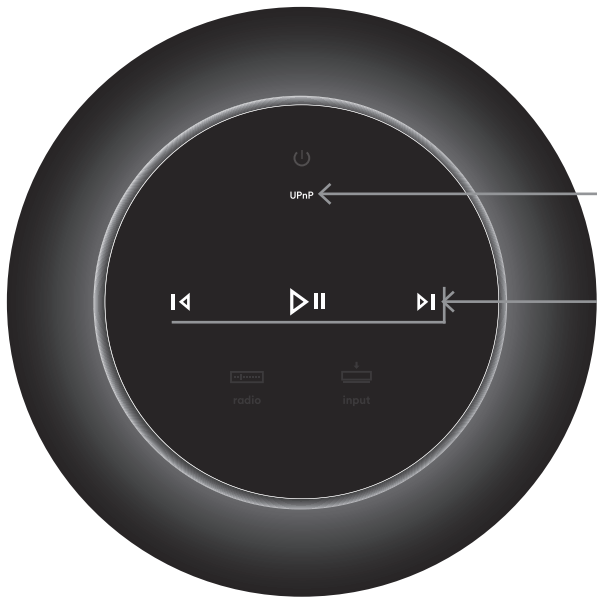

UPnP™ icon illuminated

Transport icons illuminated and active.

Note: Transport icons are only illuminated and touch-active once playback has been initiated from the Naim app or directly from a UPnP™ playback device.

Diagram 18
iRadio input

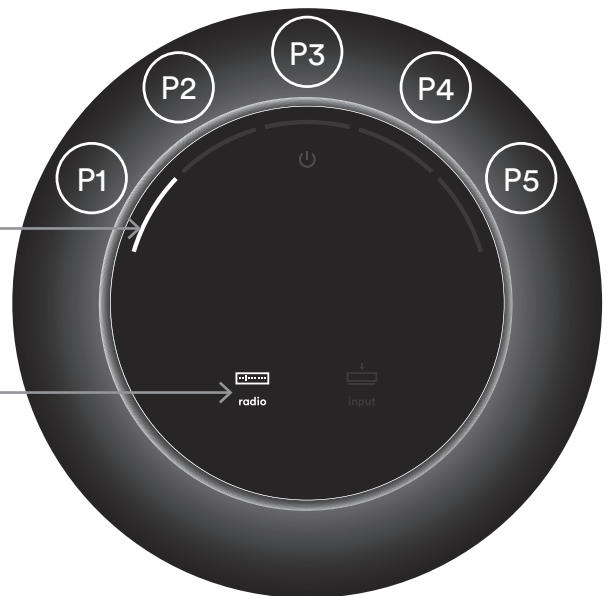

iRadio preset one selected

iRadio icon illuminated

Note: Touch the iRadio icon to select presets sequentially.

Diagram 17
Local inputs

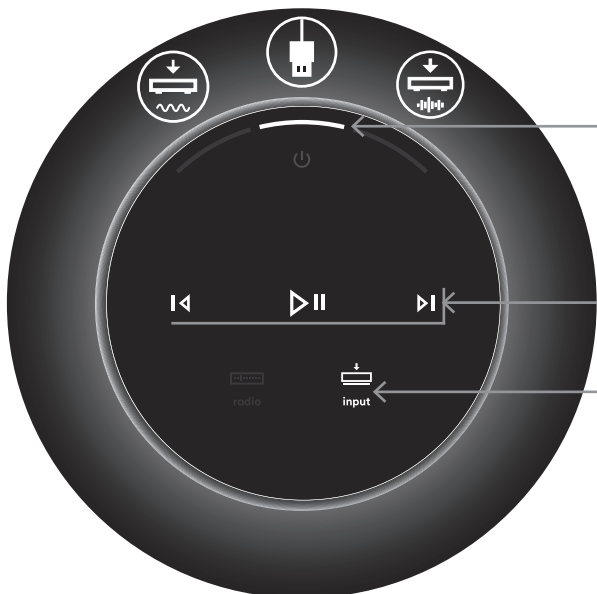

USB input selected

Transport icons illuminated and active.

USB input selected

Note: Transport icons are only illuminated and touch-active with the USB local input, and only when playback has been initiated from the Naim app or the USB device itself.

5. Control

5.2 The mu-so Remote Control Handset

Mu-so is supplied with a remote control handset that provides access to basic control functions. The handset battery is ready-fitted, however an insulating tab must be removed before the handset can be used. Remove the battery cover and pull the transparent tab away from the battery.

Unreliable operation of the remote handset is most likely due to an exhausted battery. Replacement batteries of the CR2032 type required are widely available. Take care to fit the replacement battery with the correct polarity.

The remote control handset is illustrated and its button functions annotated in Diagram 19.

Diagram 19
mu-so remote handset

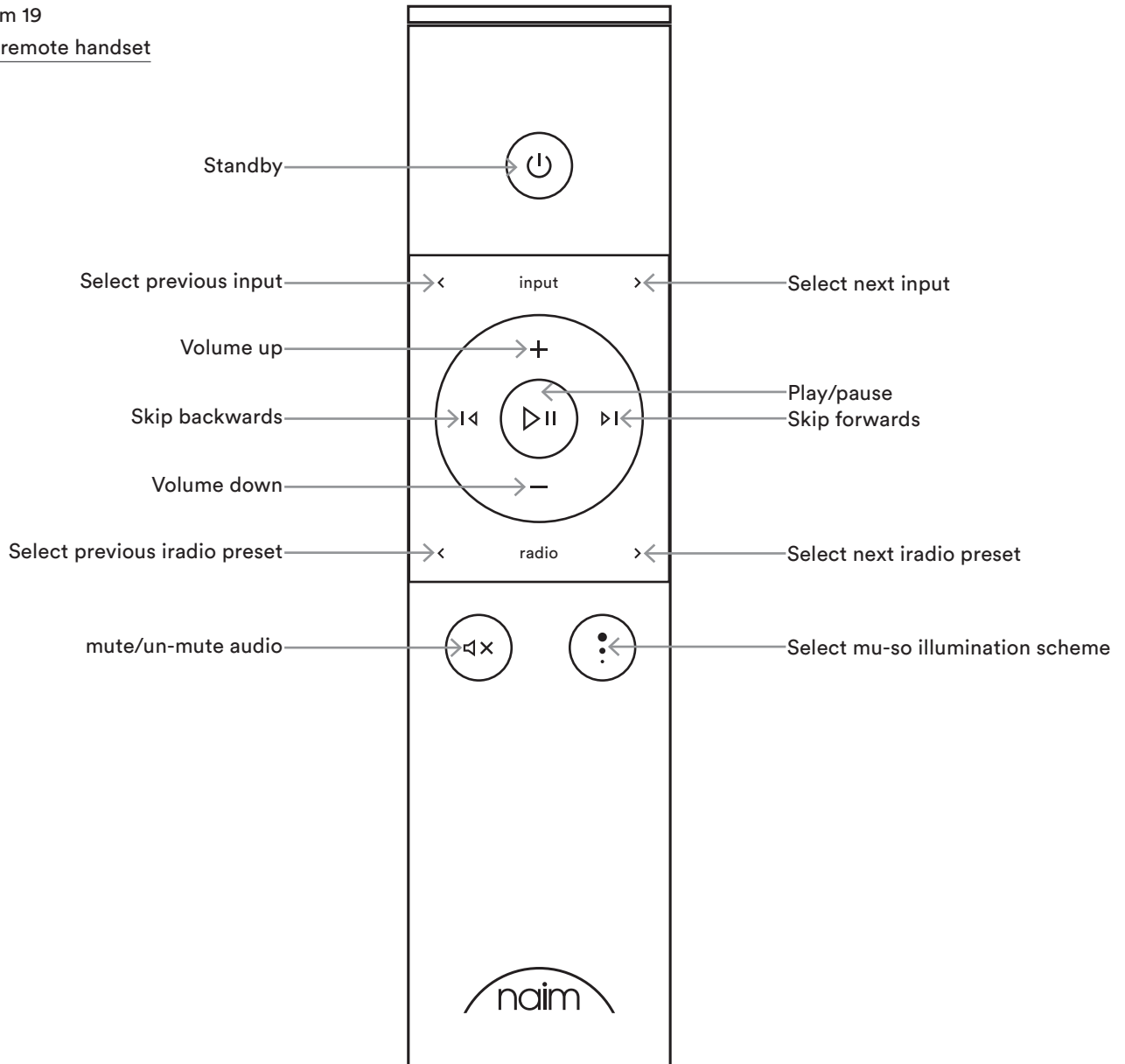

5. Control

5.3 The Naim app

The Naim app comprises pages dedicated to each of the mu-so streaming sources and inputs and pages dedicated to mu-so setup. The Naim app is intuitive in use and its capabilities and philosophies are best learned by using it to configure mu-so to suit your needs. To begin using the Naim app follow the steps below:

- Download and install the Naim app on your iOS or Android device.
- Ensure that the device is connected to the same network as the mu-so and open the Naim app.
- From the Settings menu select mu-so to connect the app. Diagram 20 illustrates selection of mu-so from the Naim app setup page.

Note: If you have multiple Naim streaming products connected to your network they will be listed for selection in the Naim app setup page. The correct unit can be identified either by its product name or, in the case of multiple identical products, by the first four characters of each units' unique MAC addresses appended to its product name. The individual mu-so MAC address can be found on the serial number label affixed to its underside.

Note: The Naim app Settings menu enables mu-so and Naim streaming product default names to be changed. Designating each mu-so or streamer with a name that

Diagram 20
Naim app Setup

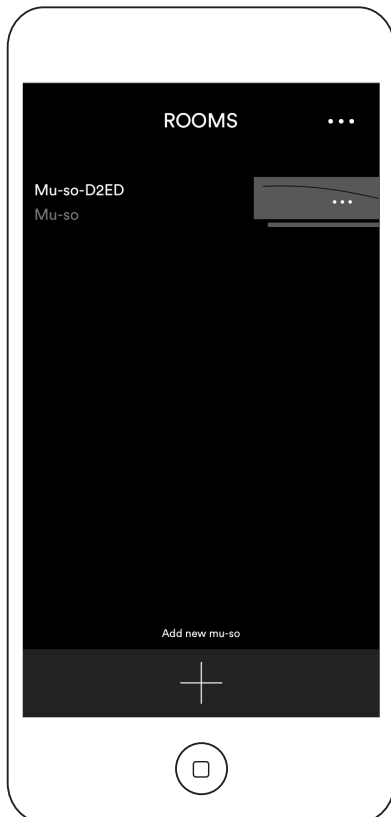

reflects their location will help make multiroom control more satisfying and intuitive. See Section 5.3.2.

5.3.1 Selecting Inputs from the Naim app

With your mu-so selected, the Naim app Input icons will configure to reflect the inputs available. Select the required input. Diagram 21 illustrates the Naim app home page and Input icons.

Diagram 21
Naim app Home

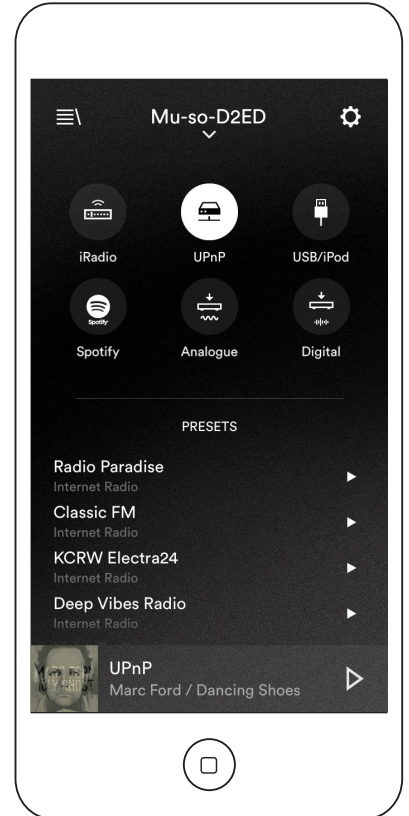

If a streaming source such as AirPlay or Spotify is selected automatically on mu-so by the presence of a stream, the Naim app display will switch to the appropriate streaming source page and offer the controls available to that stream type. If an alternative source is selected using the Naim app the stream playback will stop and mu-so will disconnect from the stream source.

Note: Only one instance of the Naim app can be connected to a single mu-so at any time.

5. Control

5.3.2 Setup using the Naim app

The Naim app provides comprehensive access to all mu-so setup parameters. All the setup parameters and functions are listed in the following paragraphs. Diagram 22 illustrates the Naim app Settings page.

The Settings menu provides eight items: Standby, Loudness, Lighting, Styles, Input settings, Room position, Other settings and About.

Standby

Switches mu-so into standby mode.

Loudness

Loudness applies a bass boost that decreases as volume is increased. By compensating for the ear's reduced bass sensitivity at low volume levels, loudness compensation can make low volume listening more satisfying.

Lighting

Lighting provides four illumination schemes offering options of brightness and activity.

Styles

Styles enables various Naim app background colour options to be selected.

Input settings

Input settings item provides a variety of options tailored to each type of input.

Room position

Room position enables adjustment of mu-so tonal balance to compensate for the proximity of walls and other large surfaces. If mu-so is placed on a shelf, for example, tonal adjustment can be useful in reducing the bass boost that naturally results from such a location.

Other settings

The Other menu provides seven items: Room Name, Auto Standby Time, Amazon Store, Stay Connected, Cleaning Mode, Clear Image Cache and Reset App.

About

The About menu provide third party licence information and information on mu-so firmware and connection status.

Diagram 22
Naim app
Settings

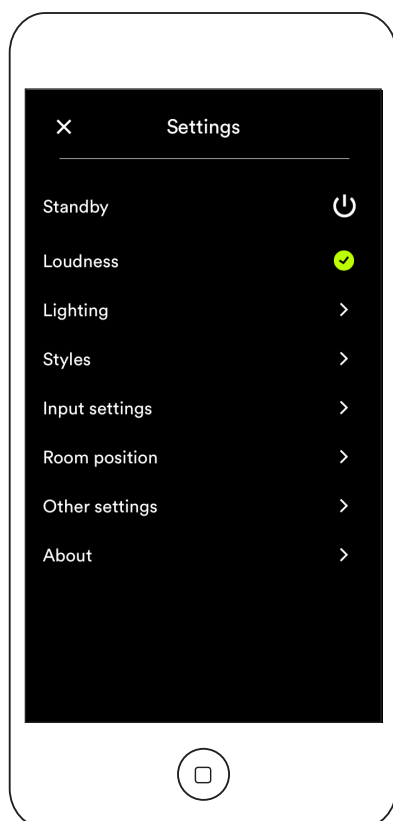

6. Installation Notes

6.1 Handling mu-so

Take great care when lifting, carrying and inverting mu-so to access the mains power, network and digital audio sockets. Do not invert mu-so so that its weight is borne by the top panel or rotary control. Do not stand mu-so on either end panel or on its front grille.

6.2 Cleaning mu-so

Your mu-so should not need cleaning beyond dusting. Do not use wax or solvent based cleaning products. If necessary, a damp cloth may be used on the external casework, however it is important that all liquids are kept away from the touch panel and rotary control.

6.3 Grille Replacement

The standard mu-so black front grille can be replaced with a range of coloured grilles available through your local Naim retailer or at naimudio.com. To remove the mu-so grille grasp both ends of the grille simultaneously and gently pull the grille away from the mu-so body. To fit a new grille, line-up the grille studs with the fixing holes in the mu-so front panel and gently push the grille home.

Note: Do not touch any of the mu-so drive-units while the grille is removed.

6.4 Firmware Update

Updated mu-so firmware may from time to time be released. Updated firmware may introduce new mu-so features or modify its existing behaviour. The Naim app incorporates a firmware update routine in its Settings menu.

Note: The Naim app firmware update routine can also be used to check that the currently installed firmware is up to date.

Important: Never switch off your mu-so or disconnect it from the mains supply or network while the firmware update procedure is underway.

Note: The mu-so setup web page also includes a firmware update link. This should be used only on the advice of Naim support staff.

6.5 Lightning Precautions

Mu-so can be damaged by lightning and should be turned off and disconnected from the mains and any wired connection when there is risk of lightning.

6.6 Defaults

To return mu-so to its default settings use the pin-tool supplied (or a straightened paperclip) to press and hold the pin-hole button located on the right-hand side panel. Hold the button pressed for six seconds. Mu-so will return to its default settings and restart. The rotary control and logo illumination will flash while the factory default procedure is underway.

6.7 Problems?

Consumer protection varies from country to country. In most territories a retailer must be prepared to take back any equipment sold if it cannot be made to work satisfactorily. A problem may be due to a fault in the product or its installation. Please contact your local distributor, or Naim Audio directly, if any difficulties cannot be resolved. Contact Naim Audio directly for help and advice if necessary.

6.8 Service and Contact

It is essential that repairs are only carried out by an authorised Naim retailer or at the Naim Audio factory. Direct contact to Naim for service or update information should be made initially through Customer Services:

Email: info@naimaudio.com

For help with mu-so installation and operation please email mu-sosupport@naimaudio.com or call:

+44 (0)333 321 9923 (UK)

+1 800 961 5681 (USA and Canada)

Please quote the product serial number (found on its underside panel) in all correspondence.

7. Specifications

Audio Inputs:	UPnP, [™] AirPlay, Spotify and Internet Radio via wired Ethernet or Wi-Fi Bluetooth (with aptX) USB/iOS (USB Type-A socket) Digital: Optical S/PDIF (TosLink) up to 96kHz Analogue: 3.5mm jack
Audio formats:	WAV, FLAC and AIFF up to 24bit/192kHz ALAC (Apple Lossless) up to 24bit/96kHz MP3 up to 48kHz, 320kbit (16 bit) AAC up to 48kHz, 320kbit (16bit) OGG and WMA up to 48kHz (16bit) Bluetooth SBC, AAC and aptX

Note: All formats to 48kHz maximum over wireless network.

Internet radio:	vTuner premium
Connectivity:	Ethernet (10/100Mbps) Wi-Fi (802.11b/g) Bluetooth RC5 remote-control
Speaker system	Dual, three-way.
Amplification:	6 × 75 Watts into 8 Ohms
Dimensions:	122mm (4.8") x 628mm (24.7") x 256mm (10.1")
Weight:	13kg (28.7lb)
Finish:	Brushed aluminium casework, silver anodised heatsink, black fabric grille. Grille options in Deep Blue, Vibrant Red, Burnt Orange.
Power consumption:	Typical use: 17W Standby mode: < 4W Deep sleep: < 0.5W
Mains supply:	100V, 115V or 230V, 50/60Hz

CE Declaration of Conformity

Naim Audio declares that Naim Audio products are in conformance with:
Low Voltage Directive 2006/95/EC
Electromagnetic Compatibility Directive 2004/108/EC
Restriction of Hazardous Substances (RoHS2) Directive 2011/65/EU
Waste of Electrical and Electronic Equipment Directive 2012/19/EU
Energy related Product Directive 2009/125/EC
Radio & Telecommunications Terminal Equipment (R&TTE) Directive 1999/5/EC

Naim Audio Ltd. declares that mu-so is in compliance with the essential requirements and relevant provisions of Directive 1999/5/EC. The Declaration of Conformity may be viewed by visiting:
www.naimaudio.com/support-information/mu-so/R&TTEdoc

Naim Audio products comply with the following standards:
EN60065 - Audio, video and similar electronic apparatus - Safety requirements
EN55013 - Sound and television broadcast receivers and associated equipment - Radio disturbance characteristics
EN55020 - Sound and television broadcast receivers and associated equipment - Immunity characteristics
EN61000-3-2 - Mains harmonics current emissions
EN61000-3-3 - Mains flicker emissions

Products that display the crossed-out wheeled bin logo cannot be disposed of as domestic waste. These products must be disposed of at facilities capable of re-cycling them and appropriately handling any waste by-products. Contact your local authority for details of the nearest such facility. Appropriate recycling and waste disposal helps conserve resources and protects the environment from contamination. Naim Audio offers a 'take back' scheme as part of its commitment to the Waste of Electrical and Electronic Equipment Directive 2012/19/EU. Customers wishing to return products for disposal may do so by sending them to the address below. Products returned for disposal must be clearly and unambiguously marked, "For disposal under WEEE Directive".



8. Acknowledgements



mu-so® is a registered trademark of Naim Audio Ltd. Registered in the United Kingdom and other countries.



“Made for iPod,” “Made for iPhone,” and “Made for iPad” mean that an electronic accessory has been designed to connect specifically to iPod, iPhone, or iPad, respectively, and has been certified by the developer to meet Apple performance standards. Apple is not responsible for the operation of this device or its compliance with safety and regulatory standards. Please note that the use of this accessory with iPod, iPhone, or iPad may affect wireless performance.



AirPlay works with iPhone, iPad, and iPod touch with iOS 4.3.3 or later, Mac with OS X Mountain Lion, and Mac and PC with iTunes 10.2.2 or later.

AirPlay, iPad, iPhone and iPod are trademarks of Apple Inc., registered in the U.S. and other countries.



This product incorporates Spotify software which is subject to 3rd party licences found here: www.spotify.com/connect/third-party-licenses



The Bluetooth® word mark and logos are registered trademarks owned by Bluetooth SIG, Inc. and any use of such marks by Naim Audio Ltd. is under licence. Other trademarks and trade names are those of their respective owners.



© 2012 CSR plc and its group companies.

The aptX® mark and the aptX logo are trade marks of CSR plc or one of its group companies and may be registered in one or more jurisdictions.



Wi-Fi® logo is a registered trademark of Wi-Fi Alliance.



UPnP™ is a trademark of the UPnP™ Forum.



Naim Audio Ltd., Southampton Road, Salisbury, England SP1 2LN

T: +44 (0)333 321 9923 (UK), +1 800 961 5681 (USA and Canada) E: mu-sosupport@naimaudio.com W: www.naimaudio.com

Document part No. 12-001-0280 Issue 10